

WANT TO LIVE LIFE

EAT
PLAY
LOVE
#LIFE GOALS



ONLY PLAY SPORTSWEAR:

AUTUMN/WINTER 2017

IN PROGRESS

TREND RESEARCH



GRAPHIC RESEARCH



Issey Miyake
Blue Ray Socks
\$55 \$35

PRINT TECHNIQUE SOURCING AT FACTORY

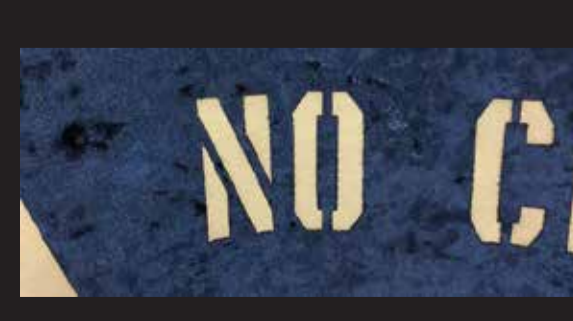
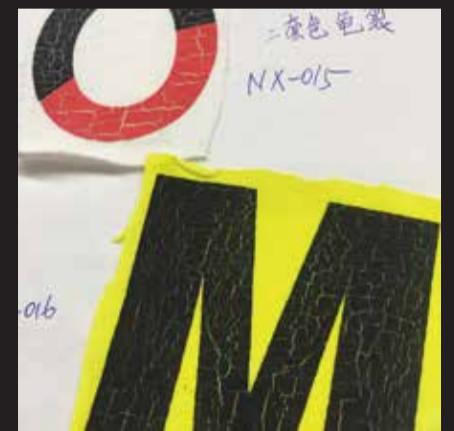
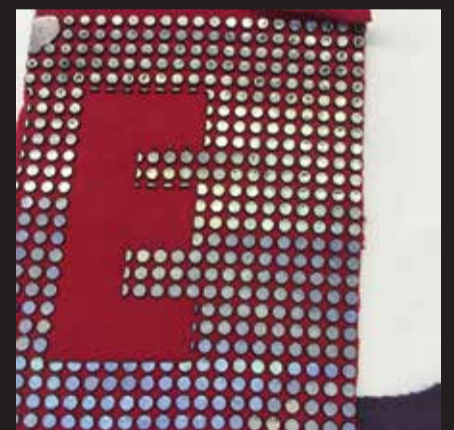
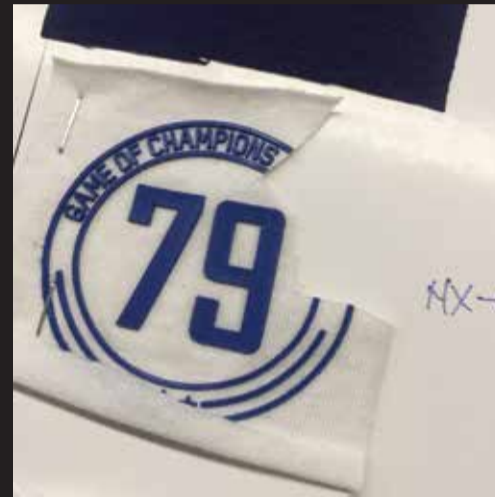
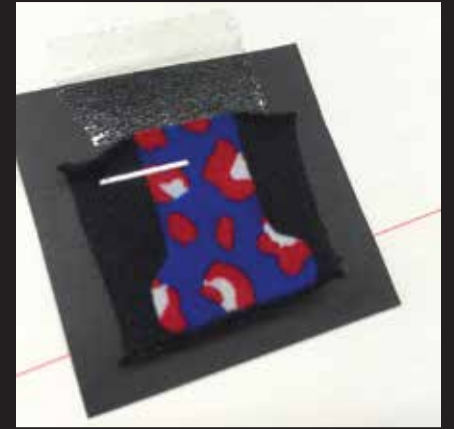



OPTION 1 FLOWER HANGTAG

10CM



EYELET

SILVER

WATERPRINT

'ONLY PLAY'
SHINY COATING

5CM



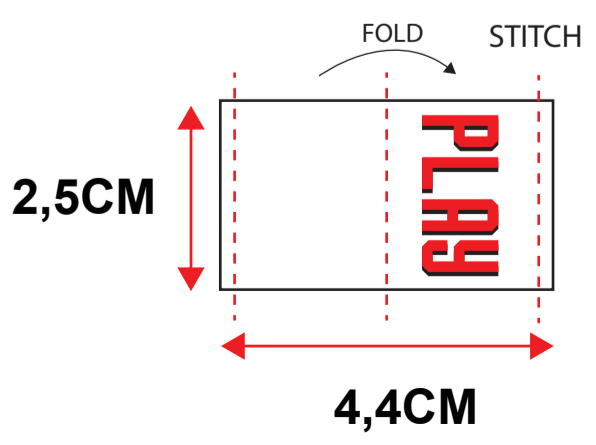

AUTUMN/WINTER 2017

1ST DROP - AUGUST



AUTUMN/WINTER 2017

1ST DROP - AUGUST



SHANGHAI NEPTUNE TRADING CO., LTD.
上海帝洋通贸易公司



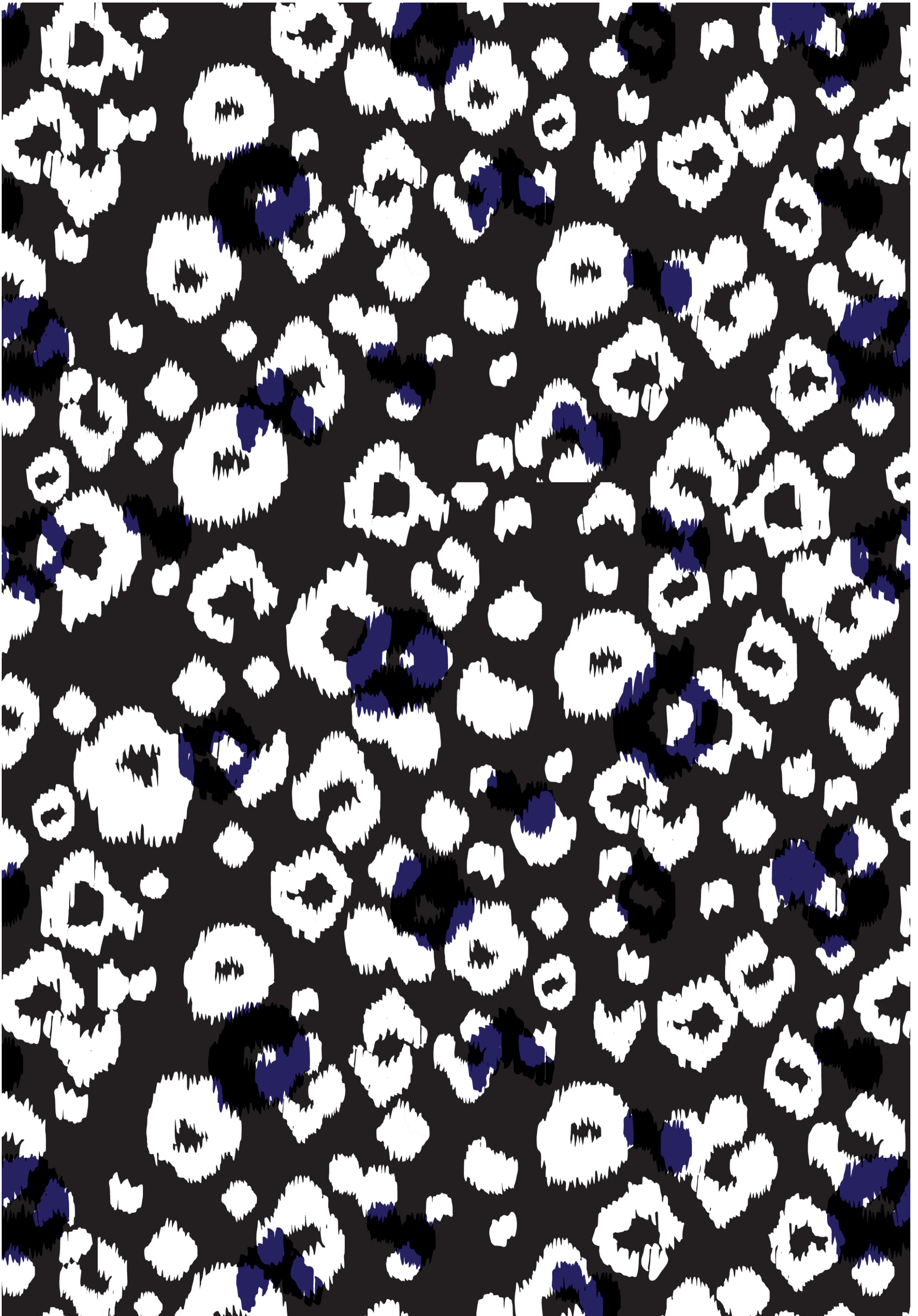

AUTUMN/WINTER 2017

1ST DROP - AUGUST

PLEAS



PLEAS

AUTUMN/WINTER 2017

1ST DROP - AUGUST



I'LL START THE GYM
ON MONDAY

ONLY PLAYS ONLY PLAYS

1ST DROP - AUGUST
PHOTOSHOOT



AUTUMN/WINTER 2017



AUTUMN/WINTER 2017



AUTUMN/WINTER 2017



AUTUMN/WINTER 2017



AUTUMN/WINTER 2017





**THANK
YOU FOR
VIEWING**

I hope i caught your interest by this short display of my work.
Please do not hesitate to contact me for further information:
MAIL_marijehester@gmail.com